

# DEJAVÙ

u r b a n lighting



**MODO:** Catalogo 2016  
**PRODUCT:** Dejavù  
**DESIGN:** Barazzuol/  
Malisan  
**YEAR:** 2015

619.232.6064 | sales@urbanlighting.net | 301 4th Avenue | San Diego, CA 92101

## INFO

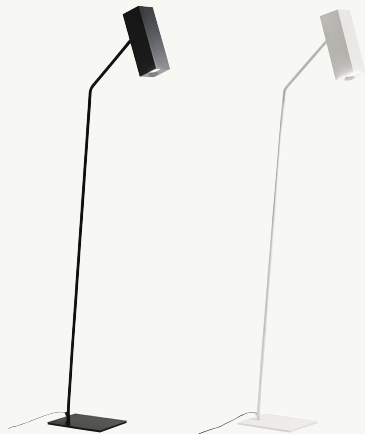

**DEJEPT192G02 — BLACK**  
**DEJEPT192G01 — WHITE**

— Lampada da terra con diffusore orientabile e pulsante per la doppia accensione. Cavo elettrico nero. Struttura metallica verniciata nei colori bianco o nero opaco, diffusore in alluminio.

— Floor lamp with rotating lampshade and double light switch. Black wiring cable. Structure in white or matt black painted metal, lampshade in aluminium.

— Lampadaire avec diffuseur orientable et bouton double allumage. Câble électrique noir. Structure en métal verni blanc ou noir matt avec diffuseur en aluminium.

## CODE & LIGHT BULBS

**DEJEPT192G01 — white**

**DEJEPT192G02 — black**

→ 25 × 60 × h 192 cm

*lampada da terra, floor lamp,  
lampadaire, Stehleuchte,  
lámpara de pié*

⊕ 2 × E27 R80 42W HES

⊕ 2 × E27 70W HES

⊕ 2 × E27 20W fluo

⊕ 2 × E27 LED

⊕ 2 × E27 R90 LED 12W

## INDOOR IP 20



— Stehleuchte mit verstellbarem Lampenschirm und Schalter für Doppelschalterung. Schwarzes Elektrokabel. Struktur aus lackiertem Metall in den Farben matt weiss oder schwarz. Lampenschirm in Aluminium.

— Lámpara de pié con difusor orientable y botón doble encendido. Cable eléctrico negro. Estructura metálica lacada mate en blanco o negro. Difusor de aluminio.

## TECHNICALS

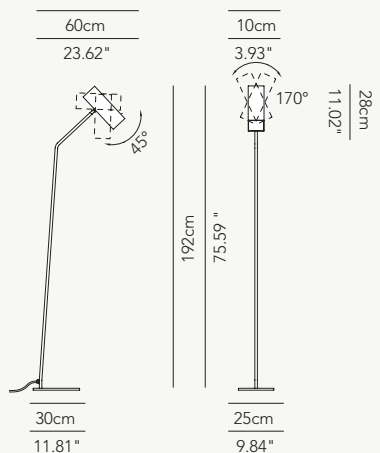

## FINISHES



white



black

# DEJAVÙ

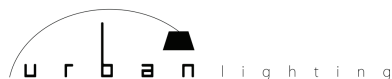

619.232.6064 | sales@urbanlighting.net | 301 4th Avenue | San Diego, CA 92101



**MODO:** Catalogo 2016  
**PRODUCT:** Dejavù  
**DESIGN:** Barazzuol/  
 Malisan  
**YEAR:** 2015

## INFO

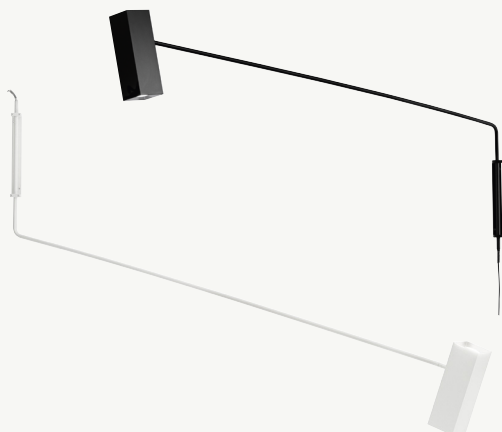

**DEJEAP209G02 - BLACK**  
**DEJEAP209G01 - WHITE**

— Lampada da parete con braccio a sbalzo girevole e diffusore orientabile. Doppia possibilità di installazione. Dotata di pulsante o predisposizione per doppia accensione. Cavo elettrico nero. Struttura metallica verniciata nei colori bianco o nero opaco, diffusore in alluminio

— Wall lamp with cantilever rotating arm and adjustable diffuser. Double installation possibility. Equipped with button or predisposition for double switch. Black wiring cable. Structure in white or matt black painted metal with aluminium lampshade.

— Applique avec bras en porte-à-faux tournant avec le diffuseur orientable. Double possibilité d'installation. Equipée avec bouton ou prédisposition à double allumage. Câble électrique noir. Structure en métal verni blanc ou noir matt avec diffuseur en aluminium.

## CODE & LIGHT BULBS

**DEJEAP170G01 — white**  
**DEJEAP170G02 — black**  
 → 170 × 10 × h 92 cm – kg. 5  
**DEJEAP209G01 — white**  
**DEJEAP209G02 — black**  
 → 209 × 10 × h 100 cm – kg.6  
*lampada da parete, wall lamp, applique, Wandleuchte, applique*

**DEJEAR000G01 — white**  
**DEJEAP000G02 — black**  
*accessorio aggancio a parete, accessory for wall fixing, accessoire pour fixation au mur, Zuberhör für Wandbefestigung, accesorio soporte de pared*

- ⊘ 2 × E27 R80 42W HES
- ⊘ 2 × E27 70W HES
- ⊘ 2 × E27 20W fluo
- ⊘ 2 × E27 LED
- ⊘ 2 × E27 R90 LED 12W

— Wandleuchte mit drehbarem Arm und verstellbarem Lampenschirm. Installation auf zwei Weisen möglich. Ausgerüstet mit Schalter oder ausgelegt für doppelschalterung. Struktur aus lackiertem Metall in den Farben matt weiss oder schwarz. Lampenschirm in Aluminium.

— Applique con brazo orientable y el difusor orientable. Doble posibilidad de instalación. Equipado con botón o la predisposición para el doble encendido. Cable eléctrico negro. Estructura metálica lacada mate en blanco o negro con difusor de aluminio.

## INDOOR IP 20



- dettaglio snodo ruotante
- rotating ball joint detail
- detail du joint pivotant
- Kugelgelenk-Detail
- particular junta rotativa



- staffa sostegno lampada da parete
- bracket support for wall lamp
- support mural pour applique
- Wandleuchten-Halterung
- brida de soporte par applique



## TECHNICALS

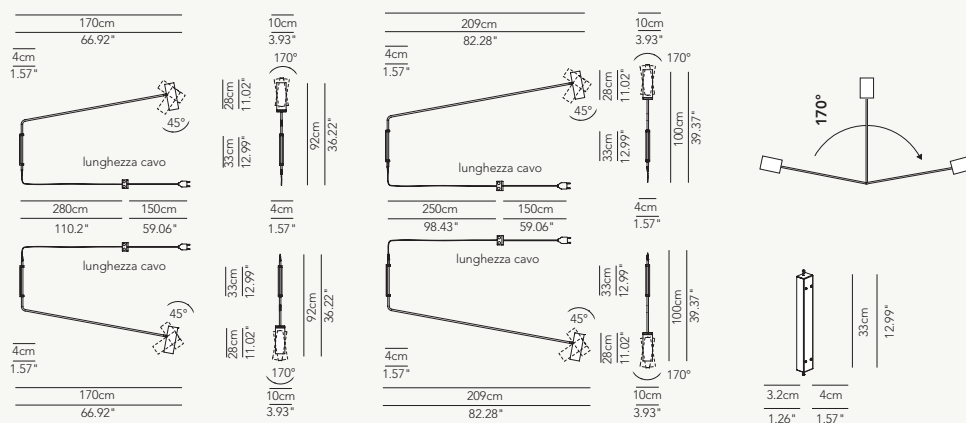

## FINISHES



# DEJAVÙ

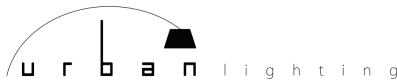

619.232.6064 | sales@urbanlighting.net | 301 4th Avenue | San Diego, CA 92101

**MODO:** Catalogo 2016  
**PRODUCT:** Dejavù  
**DESIGN:** Barazzuol/  
Malisan  
**YEAR:** 2015

## INFO



**DEJEPL165G01 – WHITE**  
**DEJEPL165G02 – BLACK**

— Lampada da soffitto con possibilità di rotazione sull'asse di 170° e diffusore orientabile. Struttura metallica verniciata nei colori bianco o nero opaco, diffusore in alluminio. Cavo elettrico in tinta con la struttura. Predisposta per la doppia accensione.

— Ceiling lamp with the possibility of rotation on the axis of 170° and adjustable diffuser. Structure in white or matt black painted metal with aluminium lampshade. Wiring cable in the same color as the structure. Designed for double switching.

## TECHNICALS

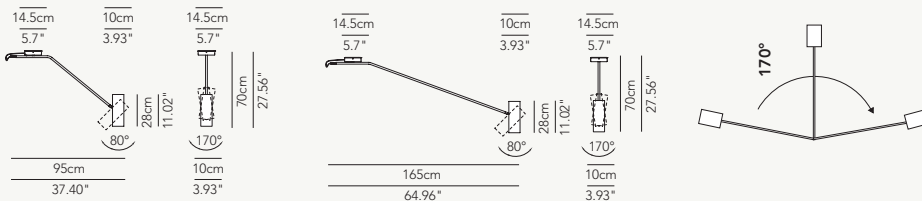

## CODE & LIGHT BULBS

**DEJEPL095G01 — white**

**DEJEPL095 G02 — black**

→ 95 × 10 × h 70 cm – kg. 4

**DEJEPL165G01 — white**

**DEJEPL165G02 — black**

→ 165 × 10 × h 70 cm – kg. 5

*lampada da soffitto, ceiling lamp, plafonnier, Deckenleuchte, plafón*

⊕ 2 × E27 R80 42W HES

⊕ 2 × E27 70W HES

⊕ 2 × E27 20W fluo

⊕ 2 × E27 LED

⊕ 2 × E27 R90 LED 12W

## INDOOR IP 20



— Plafonnier avec possibilité de rotation sur l'axe de 170° et le diffuseur orientable. Structure en métal verni blanc ou noir matt avec diffuseur en aluminium. Câble électrique dans la même couleur de la structure. Prédiposition pour double allumage.

— Deckenleuchte mit der Möglichkeit der Drehung auf der Achse um 170° und verstellbarem Lampenschirm. Struktur aus lackiertem Metall in den Farben matt weiss oder schwarz. Lampenschirm in Aluminium. Elektrokabel in der gleichen Farbe der Struktur. Ausgelegt für Doppelschalterung.

— Plafón con la posibilidad de rotación en el eje de 170° y el difusor orientable. Estructura metálica lacada mate en blanco o negro con difusor de aluminio. Cable eléctrico del mismo color de la estructura. Diseñado para el doble encendido.

## FINISHES



white



black

# DEJAVÙ

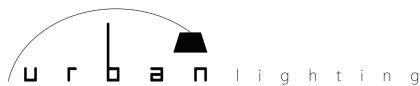

619.232.6064 | sales@urbanlighting.net | 301 4th Avenue | San Diego, CA 92101

**MODO:** Catalogo 2016  
**PRODUCT:** Dejavù  
**DESIGN:** Barazzuol/  
Malisan  
**YEAR:** 2015

## INFO



## CODE & LIGHT BULBS

**DEJEAP028G01** — white

**DEJEAP028G02** — black

→ 15 × 10 × h 28 cm – kg. 1,50

*applique orientabile 90°, wall lamp rotating 90°, applique orientable 90°, Wandleuchte verstellbar 90°, applique orientable 90°*

## INDOOR IP 20



## DEJEAP028G02 – BLACK DEJEAP028G01 – WHITE

— Applique con diffusore orientabile sull'asse di 90°. Predisposta per doppia accensione. Struttura metallica verniciata nei colori bianco o nero opaco, diffusore in alluminio.

— Wall lamp with the possibility of rotation on the axis of 90°. Designed for double switching. Structure in white or matt black painted metal with aluminium lampshade.

— Applique avec possibilité de rotation sur l'axe de 90°. Prédiposition pour double allumage. Structure en métal verni blanc ou noir matt avec diffuseur en aluminium.

— Wandleuchte mit der Möglichkeit der Drehung auf der Achse um 90°. Ausgelegt für Doppelschalterung. Struktur aus lackiertem Metall in den Farben matt weiss oder schwarz. Lampenschirm in Aluminium.

— Aplique con la posibilidad de rotación en el eje de 90. Diseñado para el doble encendido. Estructura metálica lacada mate en blanco o negro con difusor de aluminio.

## TECHNICALS

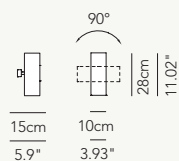

## FINISHES



white



black