

ANGELICA

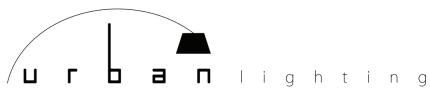

619.232.6064 | sales@urbanlighting.net | 301 4th Avenue | San Diego, CA 92101

MODO: Catalogo 2016
PRODUCT: Angelica
DESIGN: Paolo Grasselli + Modoluce R&D
YEAR: 2011

INFO



CODE & LIGHT BULBS

ANGEPT230C01 white

→ ø 60 × 175/210 × h 200/230 cm

ANGEPT230C02 black

→ ø 60 × 175/210 × h 200/230 cm

lampada da terra, floor lamp, lampadaire, Stehleuchte, lampara de pie

⊘ 1 × E27 globo 25W fluo

⊘ 1 × E27 globo 14W LED

INDOOR IP 20



ANGEPT230C01 — ANGEPT230C02

— Lampada da terra con braccio a sbalzo regolabile in 2 posizioni. Diffusore in tessuto di cotone, lycra o washable. Struttura in metallo verniciato nei colori bianco o nero.

— Floor lamp with cantilever arm adjustable in 2 positions. Lampshade in cotton, lycra or washable fabric. Painted white or black metal structure.

— Lampadaire avec bras en porte-à-faux réglable en deux positions. Diffuseur en coton, lycra ou tissu washable. Structure en métal verni blanc ou noir.

werden. Lampenschirm aus Baumwolle, Lycra oder Stoff washable. Struktur aus weiß oder schwarz lackiertem Metall.

— Lámpara de pie con brazo angular regulable en dos posiciones. Difusor en algodón, lycra o tela washable. Estructura en metal lacado en blanco o negro.

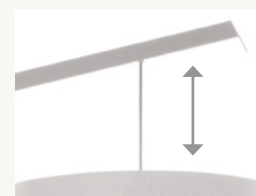

- cavo regolabile
- adjustable cable
- câble réglable
- Einstellbares Kabel
- cable regulable

TECHNICALS

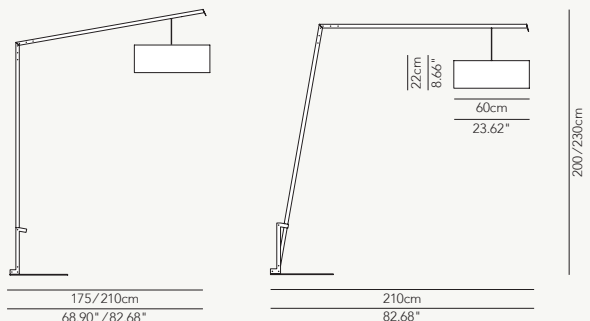

FINISHES



* on demand

ANGELICA

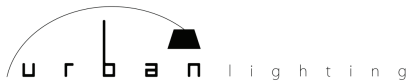

619.232.6064 | sales@urbanlighting.net | 301 4th Avenue | San Diego, CA 92101



MODO: Catalogo 2016
PRODUCT: Angelica
DESIGN: Paolo Grasselli + Moduluce R&D
YEAR: 2011

INFO



ANGEAP200C01

— Lampada da parete con braccio a sbalzo ruotante 160° sull'asse. Diffusore in tessuto di cotone, lycra o washable. Struttura in metallo verniciato nei colori bianco o nero.

— Wall lamp with cantilever arm rotating on the axis by 160°. Lampshade in cotton, lycra or washable fabric. Painted white or black metal structure.

— Applique avec bras en porte-à-fax, tournant 160° sur l'axe. Diffuseur en coton, lycra ou tissu washable. Structure en métal verni blanc ou noir.

— Wandleuchte mit verstellbarem Arm, um 160° auf der Achse drehbar. Lampenschirm aus Baumwolle, Lycra oder Stoff washable. Struktur aus weiß oder schwarz lackiertem Metall.

— Aplique con brazo angular con rotación de 160° sobre el eje. Difusor en algodón, lycra, o tela washable. Estructura en metal lacado blanco o negro.

CODE & LIGHT BULBS

ANGEAP135C01 white

→ ø 45 × 120 × h 80 cm – kg 2,50

ANGEAP135C02 black

→ ø 45 × 120 × h 80 cm – kg 2,50

ANGEAP180C01 white

→ ø 45 × 170 × h 90 cm – kg 3,00

ANGEAP180C02 black

→ ø 45 × 170 × h 90 cm – kg 3,00

ANGEAP200C01 white

→ ø 45 × 200 × h 96 cm – Kg 3,50

ANGEAP200C02 black

→ ø 45 × 200 × h 96 cm – Kg 3,50

⊘ 1 × E27 globo 25W fluo

⊘ 1 × E27 globo 14W LED

INDOOR IP 20

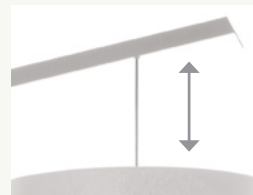

- cavo regolabile
- adjustable cable
- câble réglable
- Einstellbares Kabel
- cable regulable



- accessorio aggancio a parete
- accessory for wall fixing
- accessoire pour fixation au mur
- Zubehör für Wandbefestigung
- accesorio soporte de pared

TECHNICALS

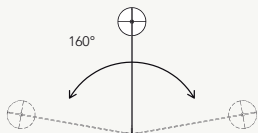
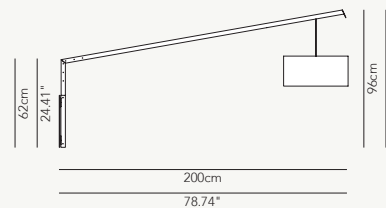
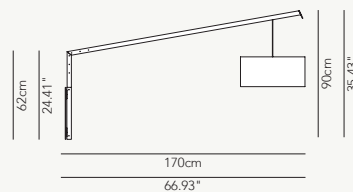
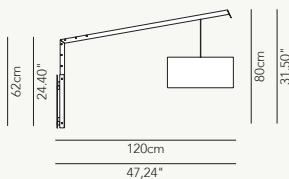

FINISHES



* on demand