

Volver, Breath of new *Light*

design Studio 14
terzani.com

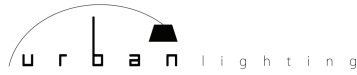

619.232.6064 | sales@urbanlighting.net | 301 4th Avenue | San Diego, CA 92101



Type		suspension
Materials		brass chains and metal structure plated as below
Finishes		Code
Nickel		 0L60S E7 C8
Gold		 0L60S L6 C8
Black Nickel		 0L60S E9 C8
Bronze		 0L60S F7 C8

Designer Diego Bassetti and Architect Andrea Panzieri of Studio 14, protégés of Bruno Rainaldi, applied their multidisciplinary approach to create Terzani's first LED suspension light. This geometric design combines thin nickel chains with the latest in LED technology to create a light that is both elegant and modern. A breath of new light, Volver melds technology and art to achieve a new level of luxury.

Light Source | LED light
 Input: 100-277 Vac. 50/60Hz
 Dimmable 1 - 10V
 Total output - 5130 lumen
 Color temperature - 3000 K
 Color accuracy - 80 CRI
 Total nominal power consumption - 45 Watt
 Power supply included in canopy

Canopy |

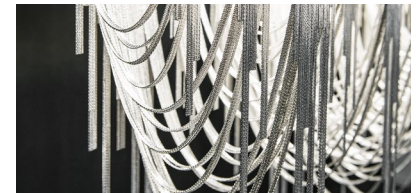
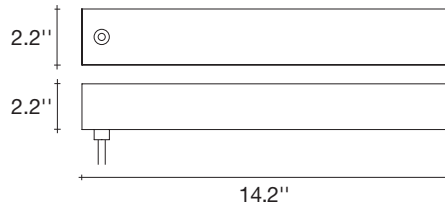

Body |

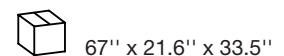
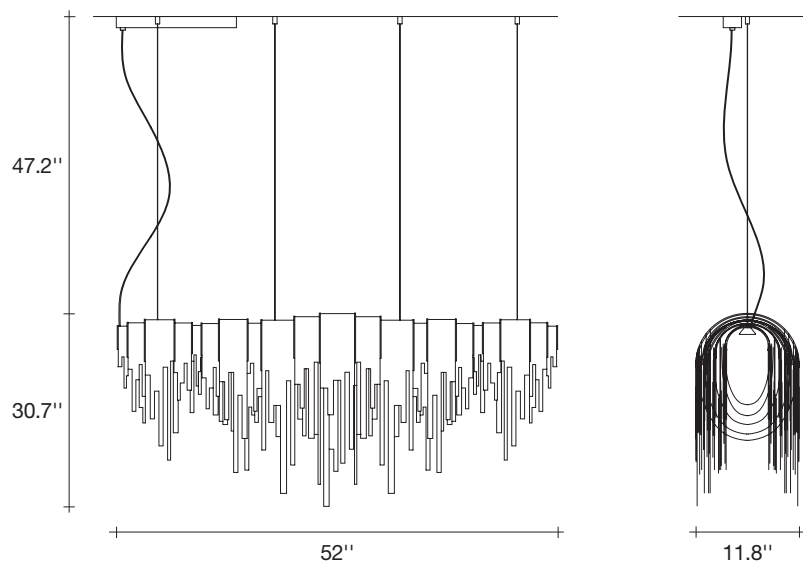

Volver, Breath of new *Light*

design Studio 14
terzani.com



Type		suspension
Materials		brass chains and metal structure plated as below
Finishes		Code
Nickel		 0L61S E7 C8
Gold		 0L61S L6 C8
Black Nickel		 0L61S E9 C8
Bronze		 0L61S F7 C8

Designer Diego Bassetti and Architect Andrea Panzieri of Studio 14, protégés of Bruno Rainaldi, applied their multidisciplinary approach to create Terzani's first LED suspension light. This geometric design combines thin nickel chains with the latest in LED technology to create a light that is both elegant and modern. A breath of new light, Volver melds technology and art to achieve a new level of luxury.

Light Source | LED light
 Input: 100-277 Vac. 50/60Hz
 Dimmable 1 - 10V
 Total output - 5130 lumen
 Color temperature - 3000 K
 Color accuracy - 80 CRI
 Total nominal power consumption - 45 Watt
 Power supply included in canopy

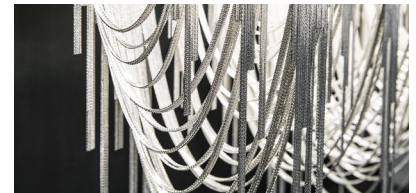

Body |

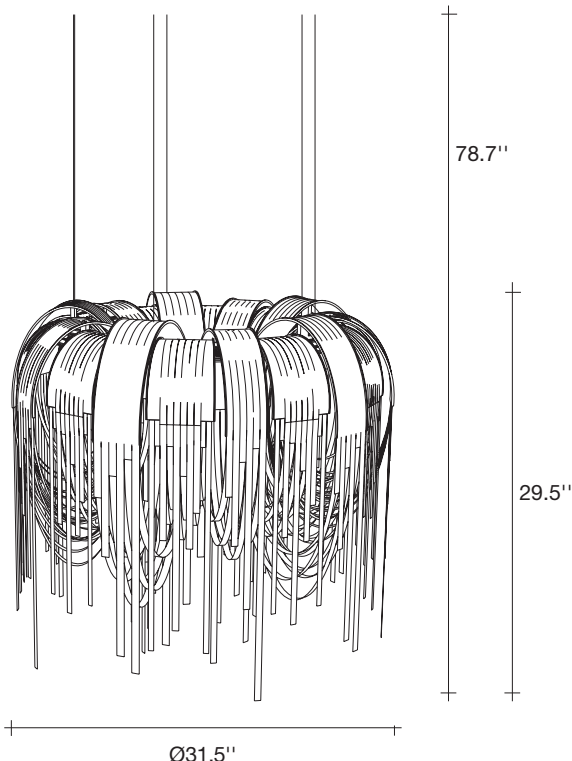

Canopy |

