

ANGELICA

u r b a n lighting



619.232.6064 | sales@urbanlighting.net | 301 4th Avenue | San Diego, CA 92101

MODO: Catalogo 2016
PRODUCT: Angelica
DESIGN: Paolo Grasselli + Modoluce R&D
YEAR: 2011

INFO



ANGEPT230C01 — ANGEPT230C02

— Lampada da terra con braccio a sbalzo regolabile in 2 posizioni. Diffusore in tessuto di cotone, lycra o washable. Struttura in metallo verniciato nei colori bianco o nero.

— Floor lamp with cantilever arm adjustable in 2 positions. Lampshade in cotton, lycra or washable fabric. Painted white or black metal structure.

— Lampadaire avec bras en porte-à-faux réglable en deux positions. Diffuseur en coton, lycra ou tissu washable. Structure en métal verni blanc ou noir.

— Stehleuchte, die Neigung kann durch den in 2 verschiedenen Stufen verstellbaren Arm variiert

CODE & LIGHT BULBS

ANGEPT230C01 white

→ ø 60 × 175/210 × h 200/230 cm

ANGEPT230C02 black

→ ø 60 × 175/210 × h 200/230 cm

lampada da terra, floor lamp, lampadaire, Stehleuchte, lampara de pie

⊕ 1 × E27 globo 25W fluo

⊕ 1 × E27 globo 14W LED

INDOOR IP 20



werden. Lampenschirm aus Baumwolle, Lycra oder Stoff washable. Struktur aus weiß oder schwarz lackiertem Metall.

— Lámpara de pie con brazo angular regulable en dos posiciones. Difusor en algodón, lycra o tela washable. Estructura en metal lacado en blanco o negro.

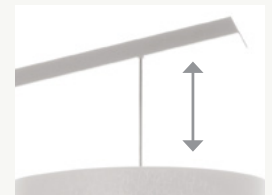

- cavo regolabile
- adjustable cable
- câble réglable
- Einstellbares Kabel
- cable regulable

TECHNICALS

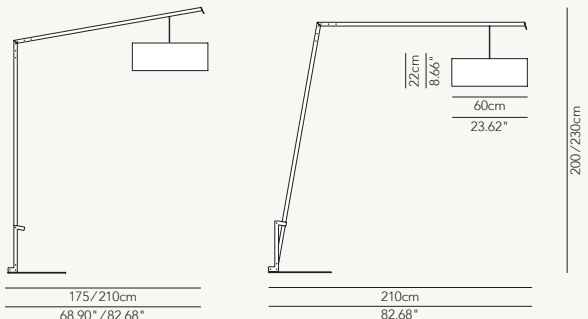

FINISHES



* on demand

ANGELICA

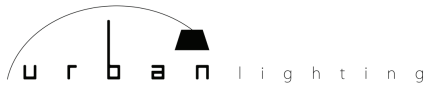

619.232.6064 | sales@urbanlighting.net | 301 4th Avenue | San Diego, CA 92101

MODO: Catalogo 2016
PRODUCT: Angelica
DESIGN: Paolo Grasselli + Modoluce R&D
YEAR: 2011

INFO



ANGEAP200C01

— Lampada da parete con braccio a sbalzo ruotante 160° sull'asse. Diffusore in tessuto di cotone, lycra o washable. Struttura in metallo verniciato nei colori bianco o nero.

— Wall lamp with cantilever arm rotating on the axis by 160°. Lampshade in cotton, lycra or washable fabric. Painted white or black metal structure.

— Applique avec bras en porte-à-fax, tournant 160° sur l'axe. Diffuseur en coton, lycra ou tissu washable. Structure en métal verni blanc ou noir.

— Wandleuchte mit verstellbarem Arm, um 160° auf der Achse drehbar. Lampenschirm aus Baumwolle, Lycra oder Stoff washable. Struktur aus weiß oder schwarz lackiertem Metall.

— Aplique con brazo angular con rotación de 160° sobre el eje. Difusor en algodón, lycra, o tela washable. Estructura en metal lacado blanco o negro.

CODE & LIGHT BULBS

ANGEAP135C01 white

→ ø 45 × 120 × h 80 cm – kg 2,50

ANGEAP135C02 black

→ ø 45 × 120 × h 80 cm – kg 2,50

ANGEAP180C01 white

→ ø 45 × 170 × h 90 cm – kg 3,00

ANGEAP180C02 black

→ ø 45 × 170 × h 90 cm – kg 3,00

ANGEAP200C01 white

→ ø 45 × 200 × h 96 cm – Kg 3,50

ANGEAP200C02 black

→ ø 45 × 200 × h 96 cm – Kg 3,50

⊘ 1 × E27 globo 25W fluo

⊘ 1 × E27 globo 14W LED

INDOOR IP 20

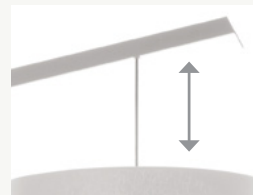

— cavo regolabile
 — adjustable cable
 — câble réglable
 — Einstellbares Kabel
 — cable regulable



— accessorio aggancio a parete
 — accessory for wall fixing
 — accessoire pour fixation au mur — Zubehör für Wandbefestigung
 — accesorio soporte de pared

TECHNICALS

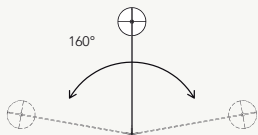
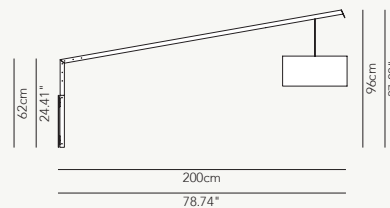
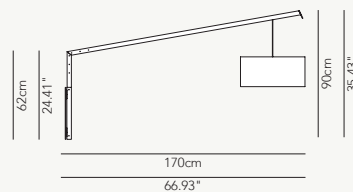
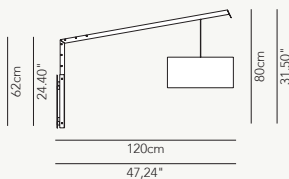

FINISHES



* on demand